

---

# INTEGRAL D6 UNIVERSAL PROCESSOR

MANUAL

---



**·:BITHOUSE:·**  
every bit matters

## Contents

About the Document .....	3
Document Scope.....	3
Safety information.....	3
Intended use .....	3
Environmental Specifications .....	3
Disposal / Recycling.....	3
<b>About the product .....</b>	<b>4</b>
Product Overview .....	4
Connectors and components.....	4
Technical Specifications.....	5
Dimensions .....	5
Power Supply .....	5
Software .....	5
Performance .....	6
IM-Modules.....	7
Module Power Supply.....	8
IM-IO816 .....	9
IM-RS485 .....	10
IM-MBUS20.....	11
IM-MBUS250.....	12
IM-USB4.....	13
<b>Procedures .....</b>	<b>14</b>
IM-IO816 wiring examples .....	14
IP-address .....	17
Accessing the Actiweb9 interface.....	18
Maintenance .....	19
Opening the enclosure .....	19
Installing or replacing a module .....	21
Using the MiniPCIe Slot .....	23
<b>Contact information .....</b>	<b>24</b>

## About the Document

### Document Scope

This document describes the Integral D6 Universal Processor and its modules, including installation and maintenance information

## Safety information

### Intended use

The product is intended for building automation and light industrial use.

Only appropriately trained people are authorized to work on and with this product. They must be familiar with applicable standards and regulations.

The product may only be used in compliance with all applicable safety regulations and directives, the specified requirements, and the technical data.

Operate the product only with the specified/recommended cables and accessories.

### Environmental Specifications

PARAMETER	VALUE	NOTE
Operating temperature	0-50°C	
Humidity	<95 % (non-condensing)	

### Disposal / Recycling

WEEE business products reception points:

[Reception points for B2B products - Elker](#)

## About the product

### Product Overview

**Integral D6 Universal Processor** is a modular logic controller. The base unit includes the main processor, an integrated slot for a 4G modem, and two Ethernet ports. In addition, the modular section provides six slots for **Integral Modules**, allowing flexible configuration for different types of communication.

- Six module slots
- 4G modem ready
- Two 10/100 Mbps Ethernet RJ45 ports
- Web interface Actiweb9

### Connectors and components

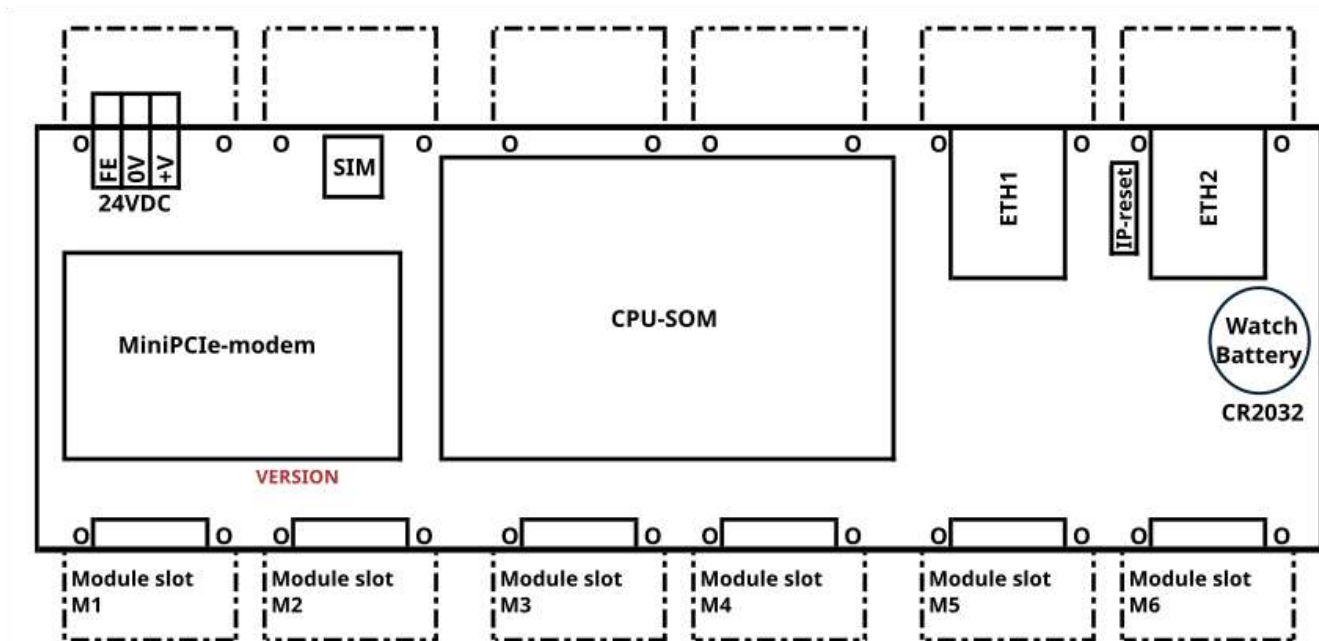

SYMBOL	PART	DESCRIPTION
FE	Connector	Functional Earth
0V	Connector	0 V <sub>DC</sub>
+V	Connector	24 V <sub>DC</sub> power supply
ETH1	Connector	Ethernet ports (identical)
ETH2		
CPU-SOM	Processor	Various options
MiniPCIe	Modem	Optional
SIM	SIM-card	
IP-reset	Button	IP-address reset
Watch Battery	Battery	CR2032
Module slots M1-M6	Integral Module	As ordered

## Technical Specifications

### Dimensions

PARAMETER	VALUE	NOTE
Width	213 mm	12 DIN modules
Height	91 mm	
Depth	60 mm	
Depth with display	71 mm	
Display size	42 x 87 mm	

### Power Supply

ATTRIBUTE	VALUE	NOTE
Operating voltage	24 V <sub>DC</sub> (±10%)	
24 V <sub>DC</sub> fuse for modules	10 A	Mini blade fuse 11x4 mm
24 V <sub>DC</sub> CPU fuse	2 A	Auto-resetting
CPU power consumption	80 mA	0 % load
	150 mA	100 % load
mPCIe modem current consumption	Approx. 100 mA	
Theoretical max consumption (1,6 A peak current)	1,3 A	Including mPCIe but not the modules or actuators.
Module power consumption	30 mA / module	Typically (for specifics, see: Modules)
Display current consumption		
Recommended power supply	1 A (24 W)	
Through-fed current	≤6 A / module	24 V <sub>DC</sub>
	≤10 A / module	0 V <sub>DC</sub>
Grounding	1 MΩ	between 0V <sub>DC</sub> – FE connectors
		⚠ Must be connected to a PELV system
		0V <sub>DC</sub> and 0V <sub>AC</sub> must be connected
Supply conductors / torque	≤ 2,5mm <sup>2</sup> / 0,5 Nm	

### Software

A customized version of the Ubuntu 22.04 LTS operating system is installed on the device. The device automatically installs official security updates released by Canonical Ltd.

Actiweb9 software platform is installed in addition to the operating system. The control and process applications run on Actiweb9.

**Performance**

MODEL	PROCESSOR	COMPONENT	VALUE	MAX. DATA POINTS
Integral D630	Verdin AM62 Dual 1GB ET	CPU	2 cores	600
		Storage	4 GB	
		RAM	1 GB	
Integral D650	Verdin AM62 Quad 2GB WB IT	CPU	4 cores	1000
		Storage	16 GB	
		RAM	2 GB	
Integral D651	Verdin iMX8MM Q 2GB IT	CPU	4 cores	1000
		Storage	16 GB	
		RAM	2 GB	
Integral D670	Verdin iMX8M Plus Quad 8GB WB IT	CPU	4 cores	2000
		Storage	32 GB	
		RAM	8 GB	

## IM-Modules

- Modules are factory-installed as ordered.
- Width of each module: 2 DIN modules (33,1 mm)
- Tightening torque: 0,2 Nm

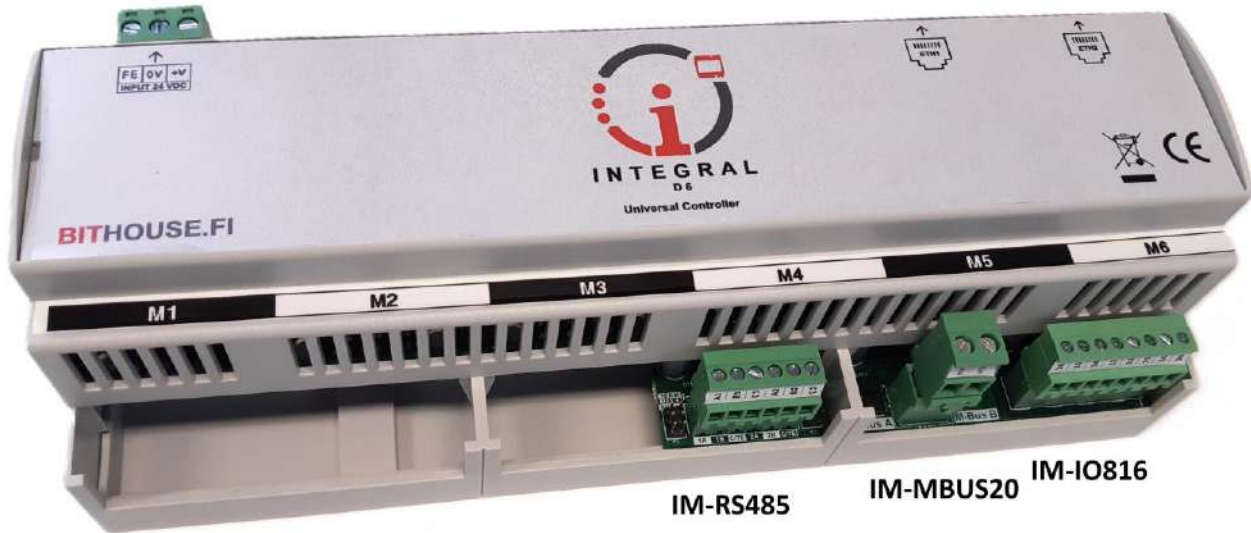

Example configuration: M1–M3 empty, M4–M6 installed (each different module).

### Module Power Supply

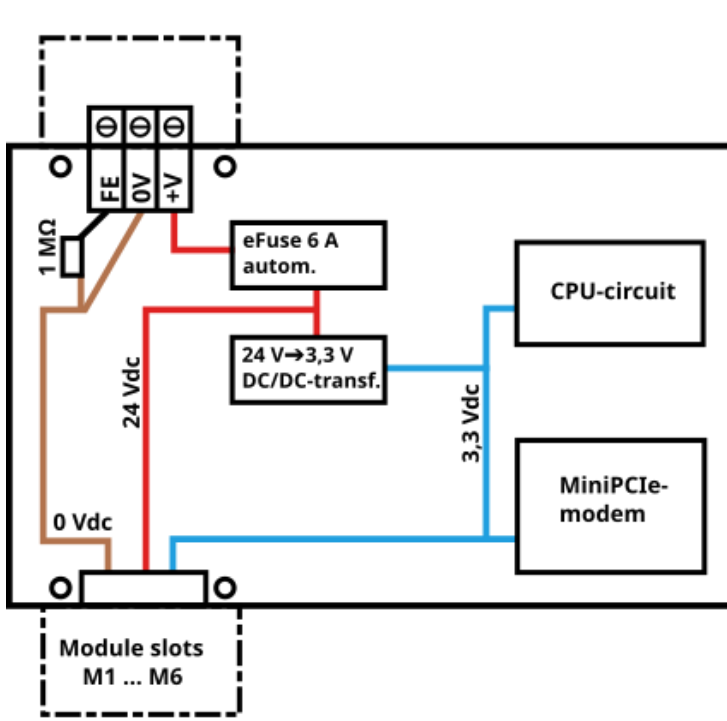

**Through-fed +24 V<sub>DC</sub> in the modules: ≤ 3 A. GND (0 V<sub>DC</sub>): ≤ 6 A.**

The CPU board supplies the modules with two voltages: **24 V<sub>DC</sub> (≤ 3 A)** and **3.3 V<sub>DC</sub> (≤ 500 mA)**. The total power consumed by these together forms the **24 V<sub>DC</sub> rated current**.

The module's **3.3 V<sub>DC</sub> power supply** passes through a **USB power switch**, which limits the current to **500 mA**. The voltage can be switched off in software, allowing the module to be rebooted (the module always receives 24 V<sub>DC</sub>).

#### **6 A fuse**

The device's supply voltage is fed through a **6 A eFuse**. It disconnects power from both the modules and the CPU board. The fuse resets automatically, with no significant delay (milliseconds).

#### **GND / 0 VDC current**

The maximum **return current** is **12 A**.

**IM-IO816**

- 16 universal I/O channels (analog measurements use two consecutive channels)
- Maximum current: 1 A per channel, 10 A per module
- Cable/tightening torque:  $\leq 1,5 \text{ mm}^2 / 0,2 \text{ Nm}$
- For analog measurements over 10 m: use twisted pair cabling
- Module power consumption: 24 V<sub>DC</sub> rated current 30 mA

**Module connectors**

SYMBOL	PART	DESCRIPTION
01-16	Connector	Analog mode: channels used in pairs (01-02, 03-04, 05-06, etc.)
		Digital mode: channels used individually

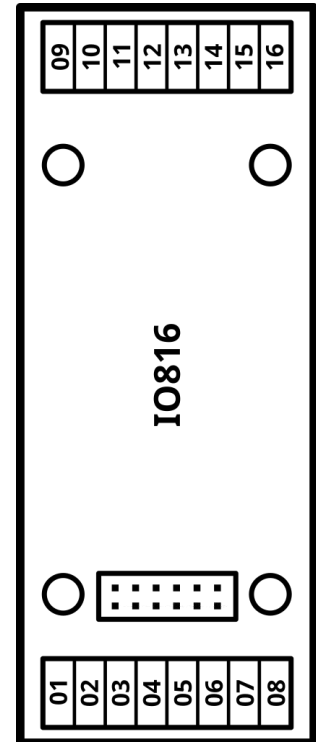

**Supported Modes**

MODE	MEASUREMENT	DESCRIPTION
AI	Resistance	PT1000, NI1000, NI1000-LG, NTC10, 0–1 MΩ
AI/AO	Voltage	0–10 V, 2–10 V
AI	Current	0–20 mA, 4–20 mA, 0–1 A (less accurate at high range)
DI	Pulse counter	Counts when connected to GND, $\geq 25 \text{ ms}$ period (400 Hz)
DI		1 = ground, 0 = float
DI-EXT		1 = voltage > 7 V, 0 = voltage < 3 V No change to previous state = 3–7 V
DO		Open drain, connects to GND when active
GND		Permanent ground

**IM-RS485**

- 2 buses per module, typically used for Modbus RTU
- Configurable bus settings:
  - Master/Slave
  - 1200–115200 bps
  - Parity N/E/O
  - 8 data bits, 1-2 stop bits (often 19200 8E1)
- Terminals A+/B- tolerate misconnection to 24 V<sub>DC</sub>
- Not galvanically isolated
- Cabling / Torque: ≤ 1.5 mm<sup>2</sup> / 0.2 Nm
- Twisted pair recommended (e.g. CAT 6)
- Power Consumption: 24 V<sub>DC</sub> rated current 30 mA (with max 54 Ω load)

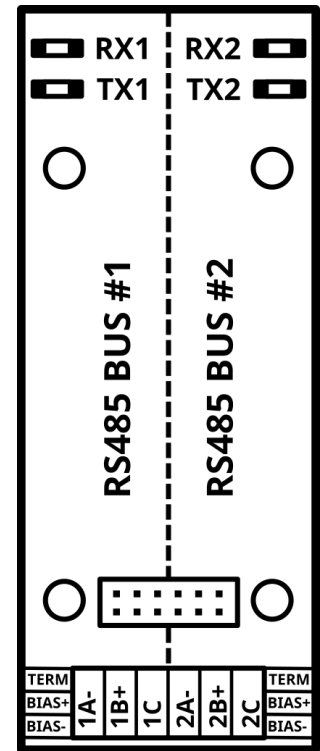

**Module connectors and components**

SYMBOL	PART	DESCRIPTION
1A-, 1B+	Connector	Bus 1. 1A negative, 1B positive
2A-, 2B+	Connector	Bus 2. 2A negative, 2B positive
1C, 2C	Connector	Ground (0 V <sub>DC</sub> ) via 100 Ω resistor
RX1, RX2	LED	Traffic on bus
TX1, TX2	LED	Outgoing traffic from module
BIAS+, BIAS-	Jumper	For bias resistors
TERM	Jumper	For 120 Ω termination

**Note:** The first production batch has different BIAS and TERM connections on Bus 2, marked separately on the housing.

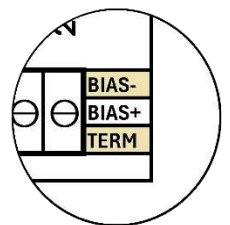

**IM-MBUS20**

- M-Bus (Meter-Bus) level converter for up to 20 devices
- Bus polarity irrelevant; ME1↔ME2 can be swapped
- Cabling / Torque: ≤ 2.5 mm<sup>2</sup> / 0.6 Nm
- Bus is not sensitive to cable type or twisted pairs
- Power Consumption:
  - 24 V<sub>DC</sub> rated current 30 mA (0 devices)
  - 24 V<sub>DC</sub> rated current 120 mA (20 devices; ~4 mA per device)

**Module connectors and components**

SYMBOL	PART	DESCRIPTION
ME1	Connector	Bus "negative" terminal (0 V)
ME2	Connector	Bus "positive" terminal (~35 V)
RX	LED	Receiving data
TX	LED	Transmitting data

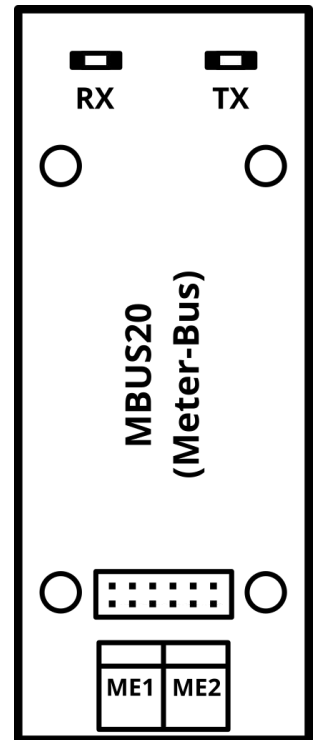

**Note:** Not a Modbus module

**IM-MBUS250**

- M-Bus (Meter-Bus) level converter for up to 250 devices
- Bus polarity irrelevant; ME1↔ME2 can be swapped
- Cabling / Torque: ≤ 2.5 mm<sup>2</sup> / 0.6 Nm
- Bus is not sensitive to cable type or twisted pairs
- Power Consumption:
  - 24 V<sub>DC</sub> rated current 30 mA (0 devices)
  - 24 V<sub>DC</sub> rated current 1000 mA (250 devices; ~4 mA per device)

**Module connectors and components**

SYMBOL	PART	DESCRIPTION
ME1	Connector	Bus "negative" terminal (0 V)
ME2	Connector	Bus "positive" terminal (~35 V)
RX	LED	Receiving data
TX	LED	Transmitting data

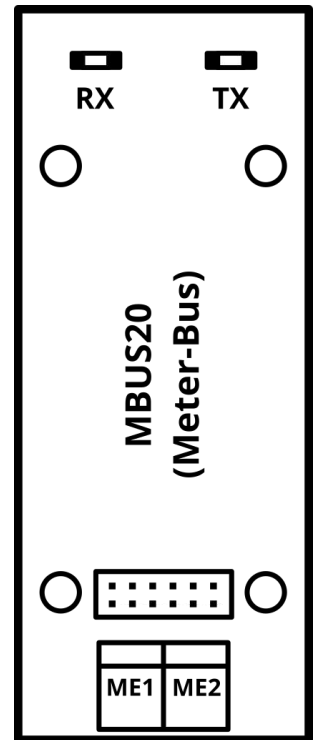

**Note:** Not a Modbus module

**IM-USB4**

- Module with four USB-C connections
- Power Consumption:
  - 24 V<sub>DC</sub> rated current 30 mA (0 devices)
  - 24 V<sub>DC</sub> rated current 2000 mA (4 devices; ~500 mA per device)

*Module connectors and components*

SYMBOL	PART	DESCRIPTION
J1...J4	Connector	USB-C

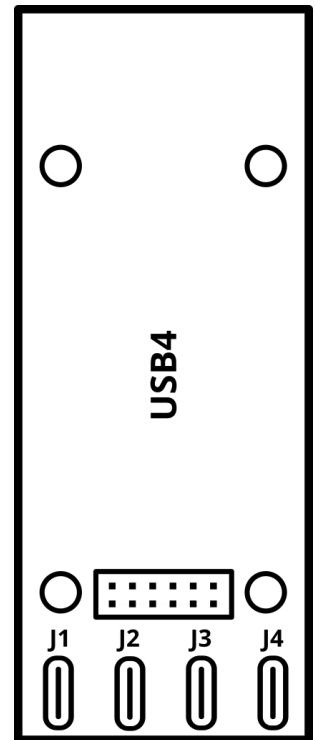

## Procedures

### IM-IO816 wiring examples

- Each IM-IO816 module provides 16 universal I/O channels.
- Digital input: 1 channel. Analog input: 2 consecutive channels.

### DI

The digital input can operate with either a voltage-based or resistance-based connection. Function is identical for even and odd channels.

#### DI-EXT (Voltage Input)

- The DI-EXT input is connected to an external voltage source.
- Logic levels:
  - 0 = voltage < 3 V
  - 1 = voltage > 7 V
  - 3–7 V retains previous state.
- Each channel includes a 100 kΩ pulldown resistor to ground. An unconnected input is interpreted as logical 0.

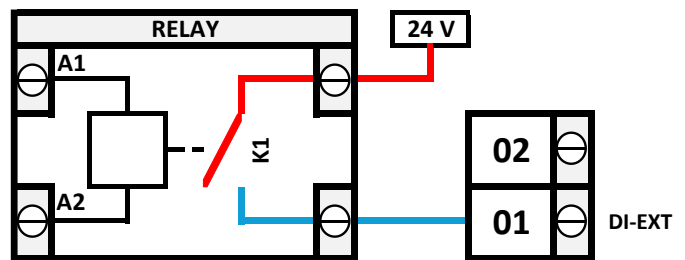

#### DI (Resistance Input)

- The DI input connects to ground (0 VDC) through a potential-free relay output or open-collector output.
- Example: Channel 01 serves as ground reference; alternatively, a terminal block can be used.
- Logic levels:
  - 0 = resistance > XXX Ω
  - 1 = resistance < XYZ Ω
  - Intermediate values retain previous state.

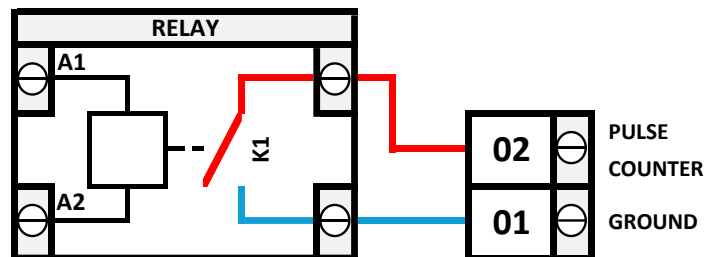
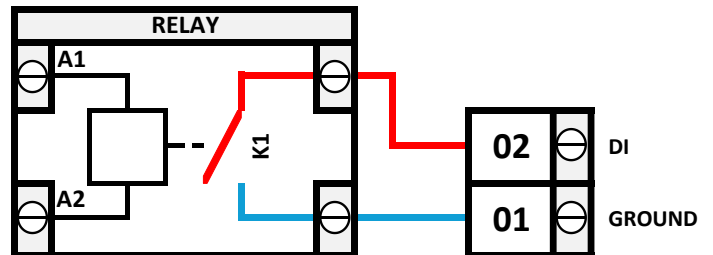

#### DI Pulse Counter

- Operates as the DI (resistance input).
- The counter increases whenever the channel switches to ground.

**DO**

Digital outputs operate in open-drain mode (equivalent to open collector).

- 0 / Off: High impedance (floating)
- 1 / On: Channel connected to ground (0 VDC)

Function is identical for even and odd channels.

Notes:

1. Each channel has a 100 kΩ resistor to ground; an LED may glow even when off.
2. Inductive load protection (24 V TVS diode to ground) protects against voltage spikes.
3. Cannot switch AC power directly—use an intermediate relay.
4. Output transistor is current-limited (>1 A cutoff).

**DO Two-Point (Potential-Free)**

- Provides isolated control via auxiliary relay.
- Terminal (01) is ground switched through the relay contacts.

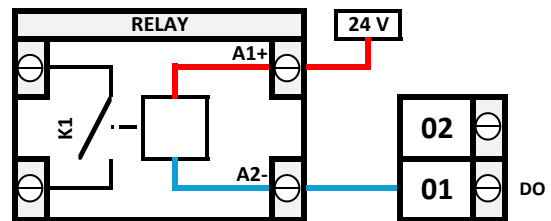

**DO Two-Point (Non-Isolated)**

- Terminal (01) is ground switched directly without isolation.

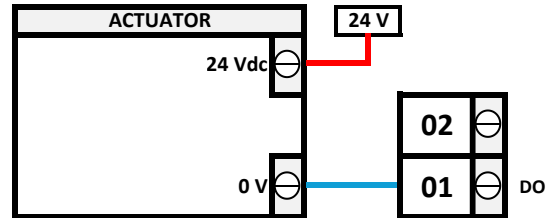

**DO Three-Point**

- Terminals (01) and (02) are ground connections used to control actuator open/close directions.
- If actuator requires two 24 VDC control inputs and one common ground, use an intermediate relay.

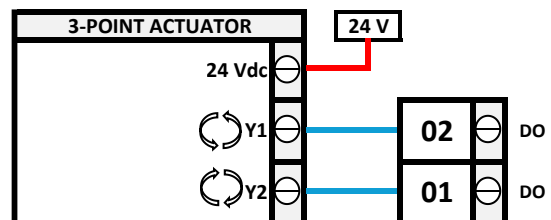

**PWM Output**

- Terminal (01) acts as ground that is rapidly switched to regulate devices such as thermal actuators.
- PWM output operates electrically like a DO output.

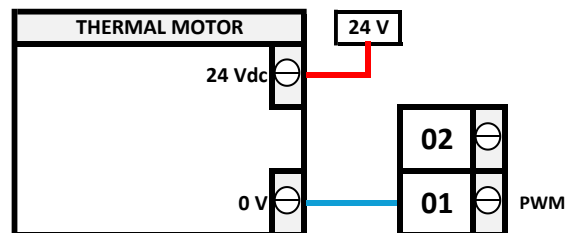

**AI**

Analog input: measurements use two consecutive channels (e.g. 01-02, 03-04, ...).

**AI High-Current Mode**

- Either terminal (odd or even) connected to ground — same as constantly active DO.
- Measurement range: 0–1 A.
- For rough monitoring, not precision measurement.

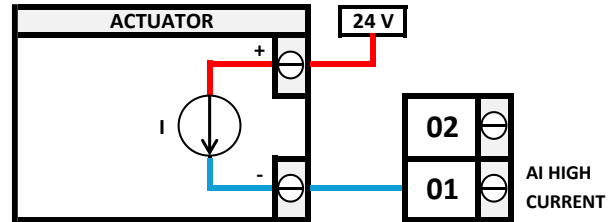

**AI Low-Current Mode**

- Odd terminal (01): Ground
- Even terminal (02): Measurement signal (0–20 mA)
- Requires external 120 Ω resistor between terminals 01 and 02.

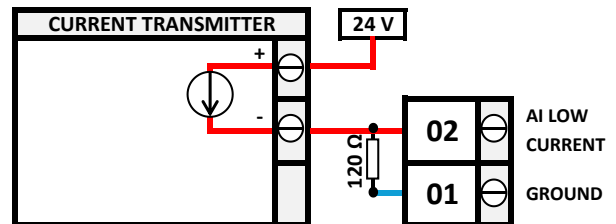
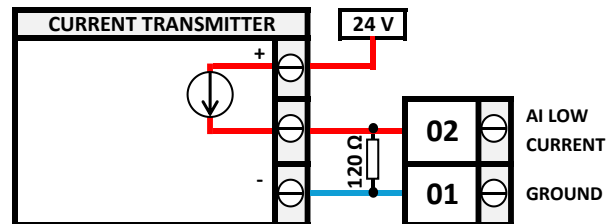

**AI Voltage Mode**

- Odd terminal (01): Ground
- Even terminal (02): Measurement signal (0–10 V).

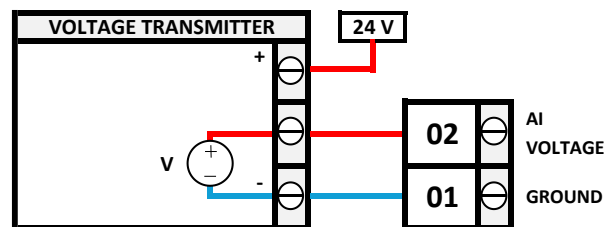

**AI Resistance Mode**

- Measures resistance between terminals 01 and 02 (0–1 MΩ).

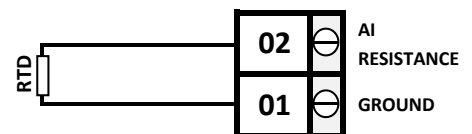

## AO

Analog outputs use two consecutive channels (e.g. 01–02, 03–04, ...).

- Even terminal (02): Control signal (0–10 V)
- Odd terminal (01): Ground.

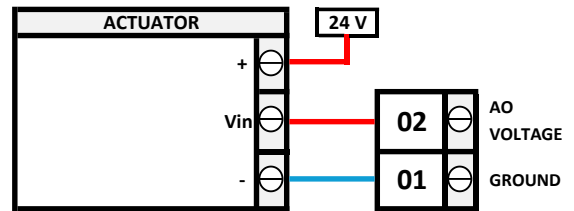

## IP-address

- Default IP Address: 192.168.0.134 (Eth1)
  - Press and hold the IP-reset button under the top cover for ~5 seconds. Restores default IP settings (temporary; not saved to disk).
  - Models with display: IP-reset button is next to the display, under a dust cover.
  - Both Ethernet ports automatically obtain an address via DHCP when available.

### DEFAULT IP SETTINGS

<b>IP-address</b>	192.168.0.134
<b>Subnet mask</b>	255.255.255.0
<b>Gateway</b>	192.168.0.1
<b>DNS</b>	192.168.0.1

### Accessing the Actiweb9 interface

The Actiweb9 software platform is accessed through a web-based user interface. The device is connected to the network via the ETH1 port.

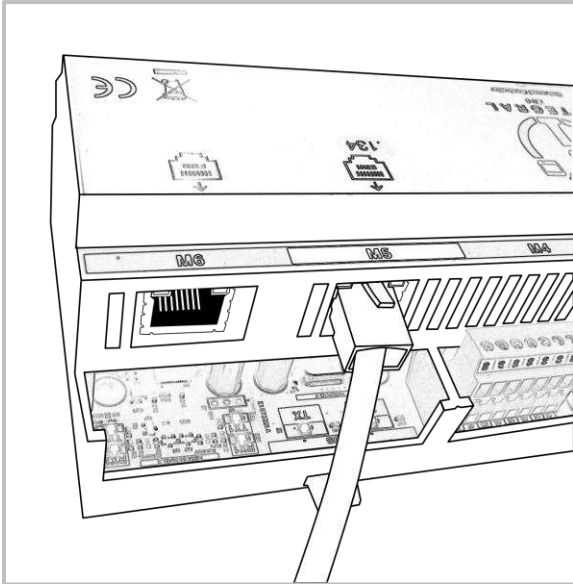

Open a web browser and navigate to the address **192.168.0.134**. Log in using the username **admin** and the password provided to you as the customer. The start page of the user interface includes a sidebar from which all functions can be accessed. Select the Logout button to sign out of the interface.

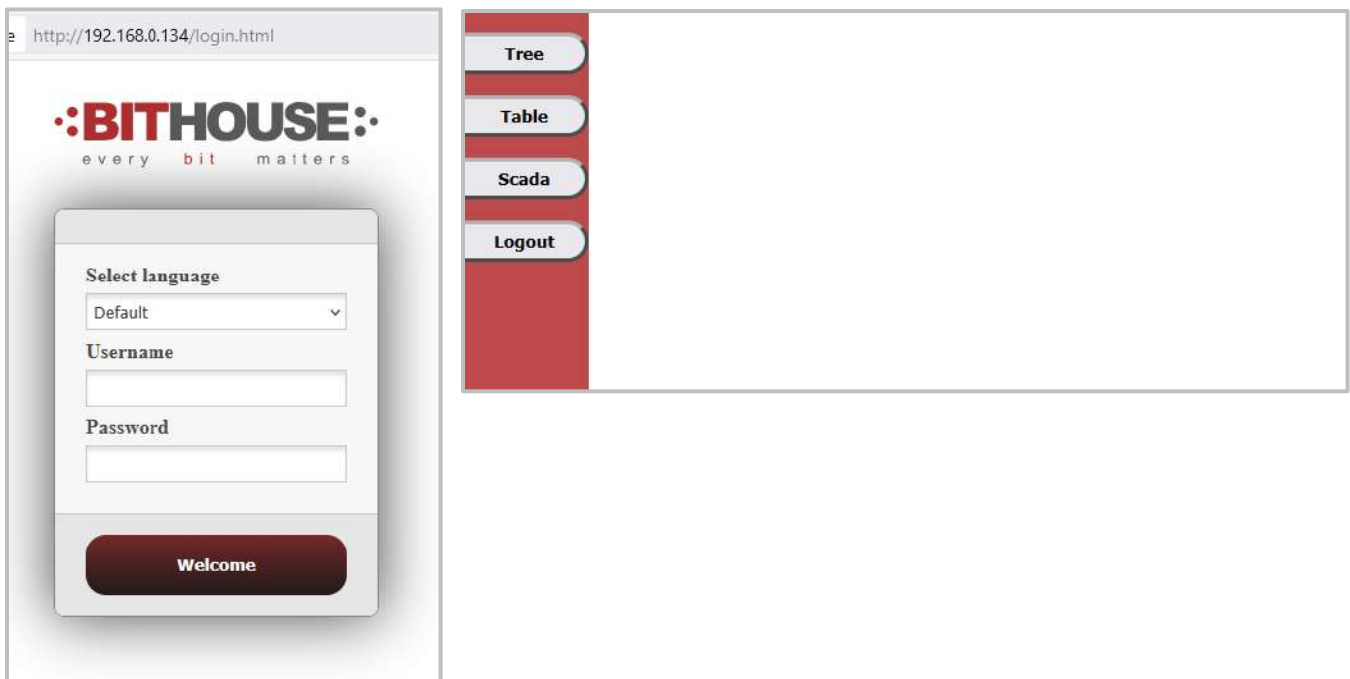

Additional instructions on using the interface: see Actiweb9 Manual (coming soon).

## Maintenance

**⚠** All maintenance procedures are to be done **power off**, unless otherwise instructed.

### Opening the enclosure

- Main housing: Detach the bottom clips first to remove the case more easily. Open from the bottom with a flat screwdriver.

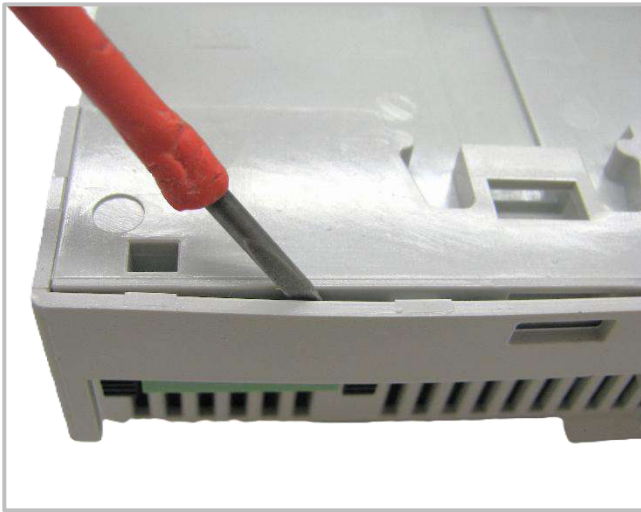
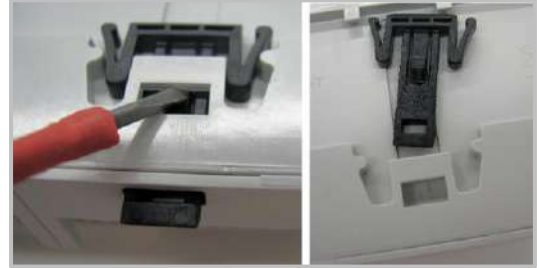

- Without display: Open the cover using a flat-head screwdriver via the notch on the edge.

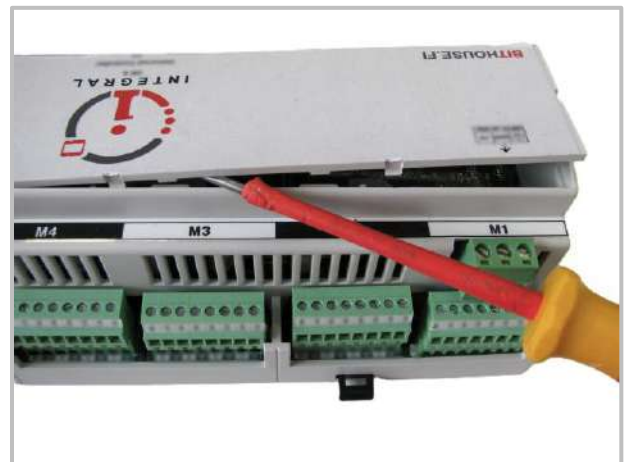

- With display: detach the display frame from the casing using a flat-head screwdriver via the notch on the edge.

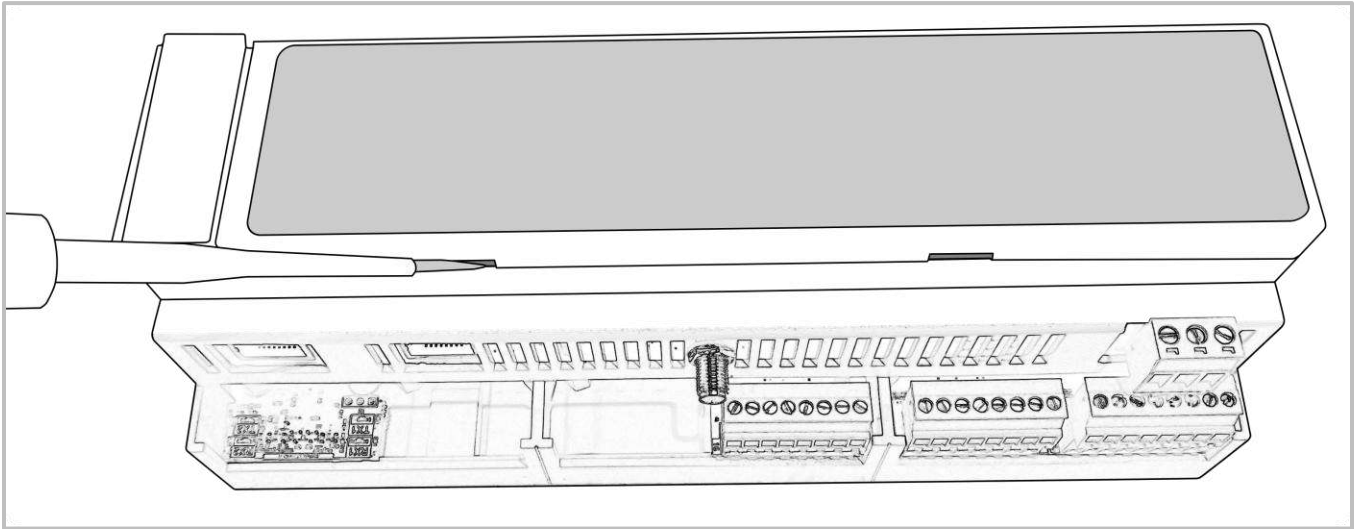

- Unplug the display cable by pressing the part of the connector marked yellow on the picture below (with the text PUSH). To plug it back in, push it evenly in to the connector, so that both edges of the connector click into place.

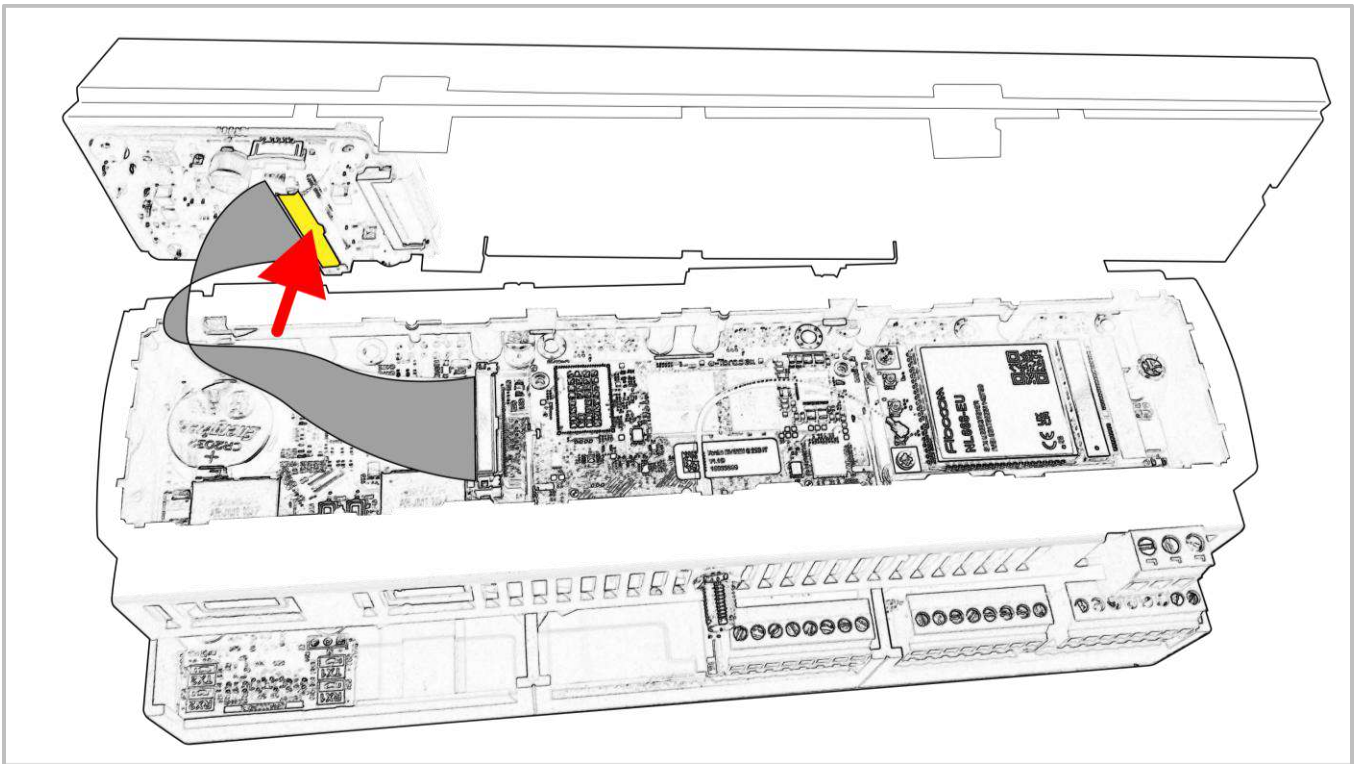

## Installing or replacing a module

### ESD precautions recommended

---

#### *Current model (with module frame)*

- The enclosure is opened by taking off the bottom of the enclosure.
- The terminal blocks of the connection points are disconnected from the module to make it easier to pull the module out of the enclosure.
- All of the modules are attached to a single module frame.
  - **Pull out** the old module and **press** the new one **in**.

#### *The previous model (screws and standoffs)*

- The enclosure is opened: both the cover/display frame and the bottom plate.
- The terminal blocks of the connection points are disconnected from the module to make it easier to pull the module out of the enclosure.
- The screws at the bottom of the module are screwed open.
- The module is pulled out and replaced with another one.

**Note:** unscrewing the module might loosen the 19mm and 8mm standoffs; a tightness check is recommended before placing the new module.

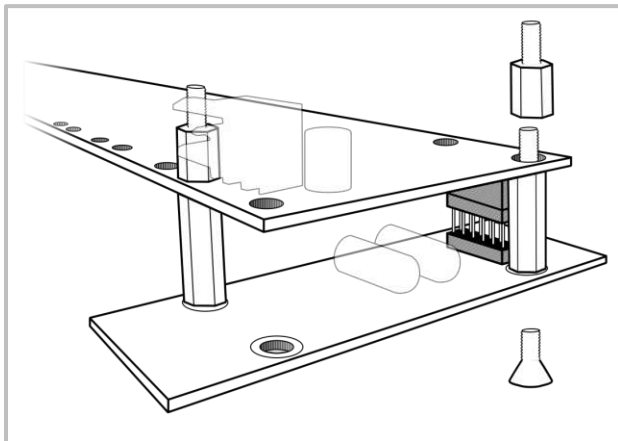

- The module is attached with two screws diagonally through the base. Screws connect to 19 mm standoffs fitted on top of the module.
- The module connects to the CPU board via a pin connector.
- The 19 mm standoffs connect to 8 mm standoffs fitted on top of the CPU board

**Note:** when placing the terminal blocks back, make sure that they are in their correct places. For example, IM-I0816 module has two similar terminal blocks, which can only be distinguished by the connection point numbers. The numbers on the circuit board should follow the order of numbers on the terminal blocks.

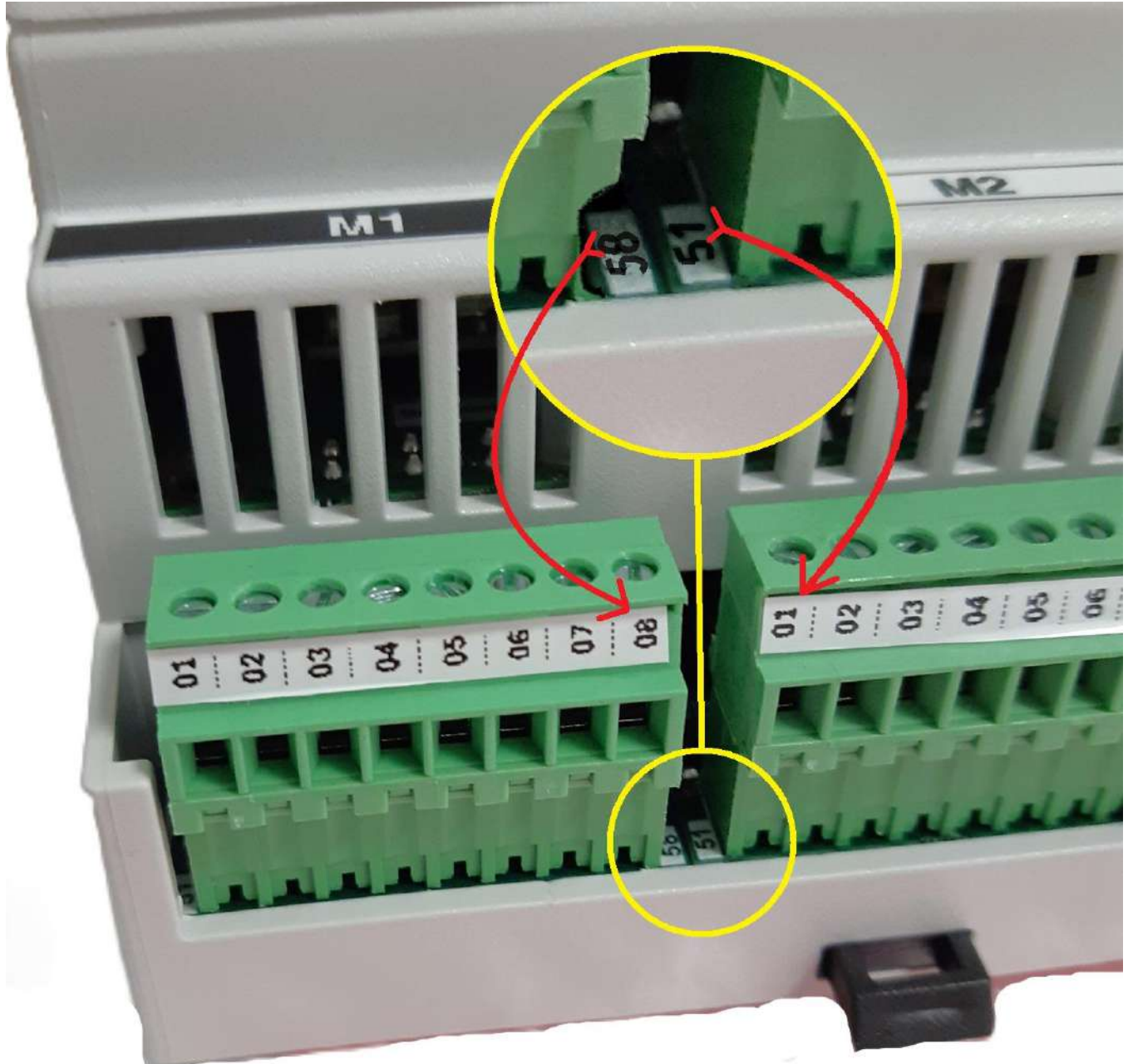

### Using the MiniPCIe Slot

The MiniPCIe slot can be used for optional expansion cards, such as a 4G/LTE modem or Bluetooth adapter.

PARAMETER	SPECIFICATION
Power supply	3.3 V (1.5 V supply not supported)
Bus interface	USB (no PCIe signals)
SIM card	Nano SIM
Antenna connection	The antenna can be installed to the enclosure opening using a short “pig tail” cable (typically ~8 cm, u.FL ↔ SMA)
Card mounting	two M2 screws

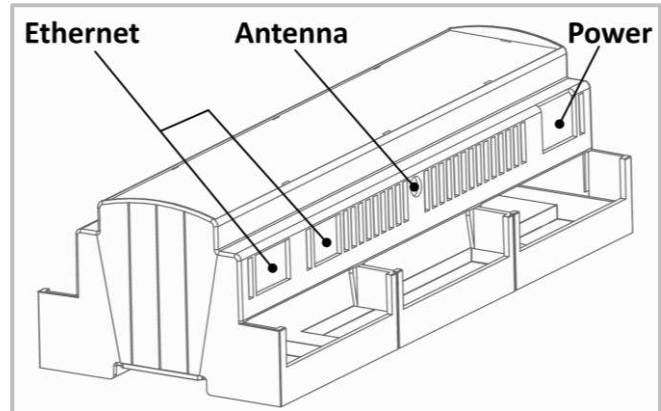
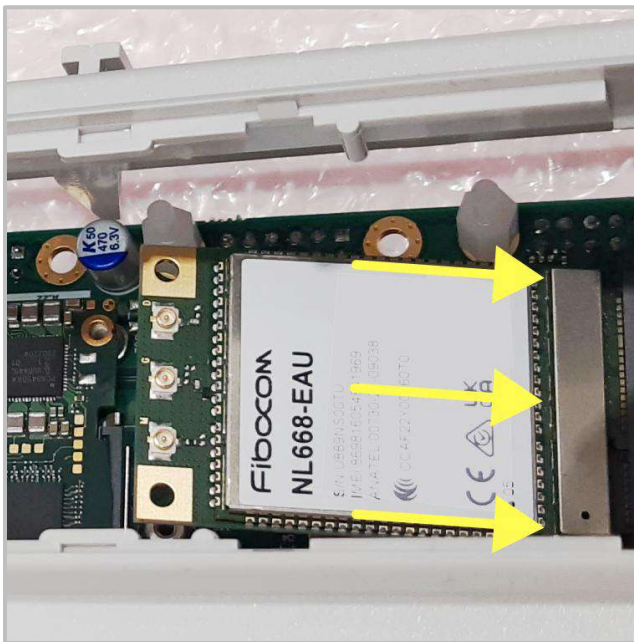

## Contact information

Bithouse Oy

[info@bithouse.fi](mailto:info@bithouse.fi)

[www.bithouse.fi](http://www.bithouse.fi)